

**THE DRAWINGS ARE
FORMAL AND TIMELY**

INITIALS TMH
DATE 02/18/05
PTO

Inventor: COOK ET AL.
Docket No. 854USC5
Title: CATEGORIZED DATA ITEM REPORTING SYSTEM AND METHOD
Attorney Name: JEFFREY P. COOK
Phone No.: 612.332.5300
Sheet 1 of 15

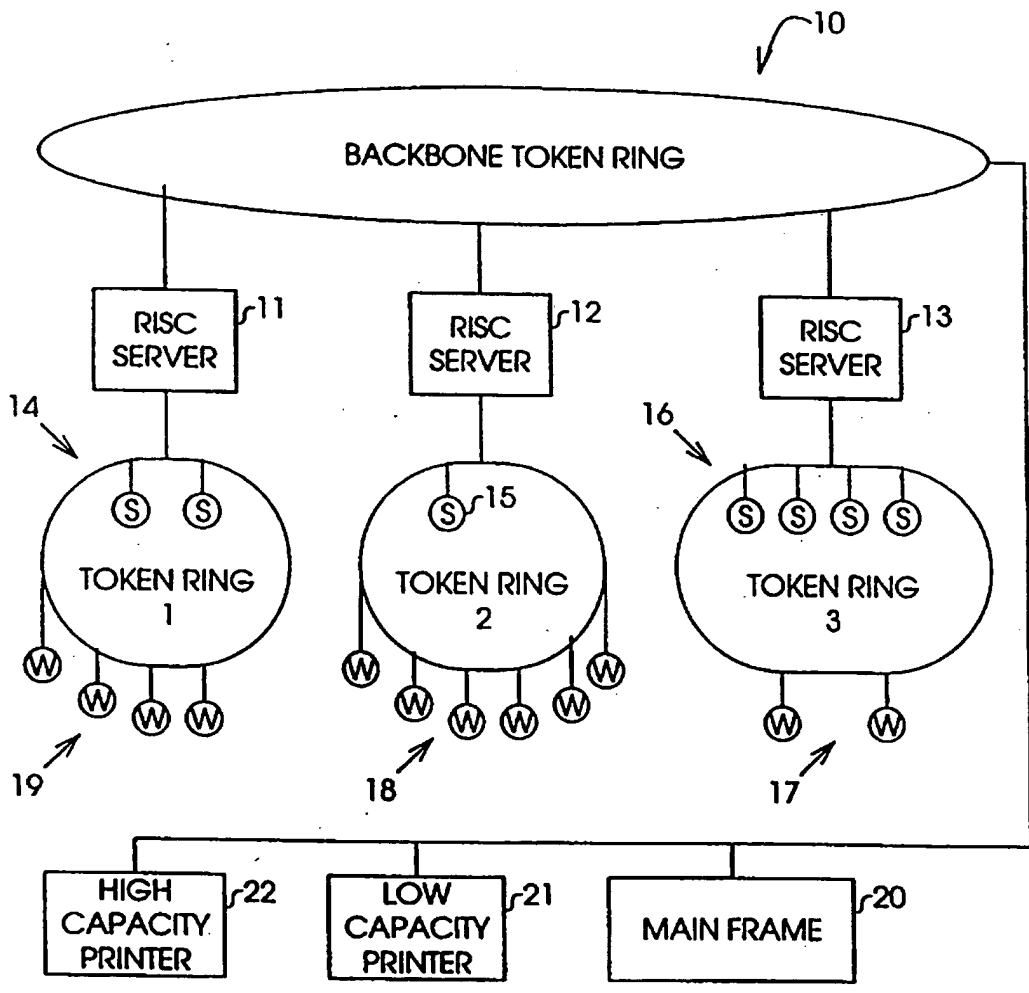

Fig. 1

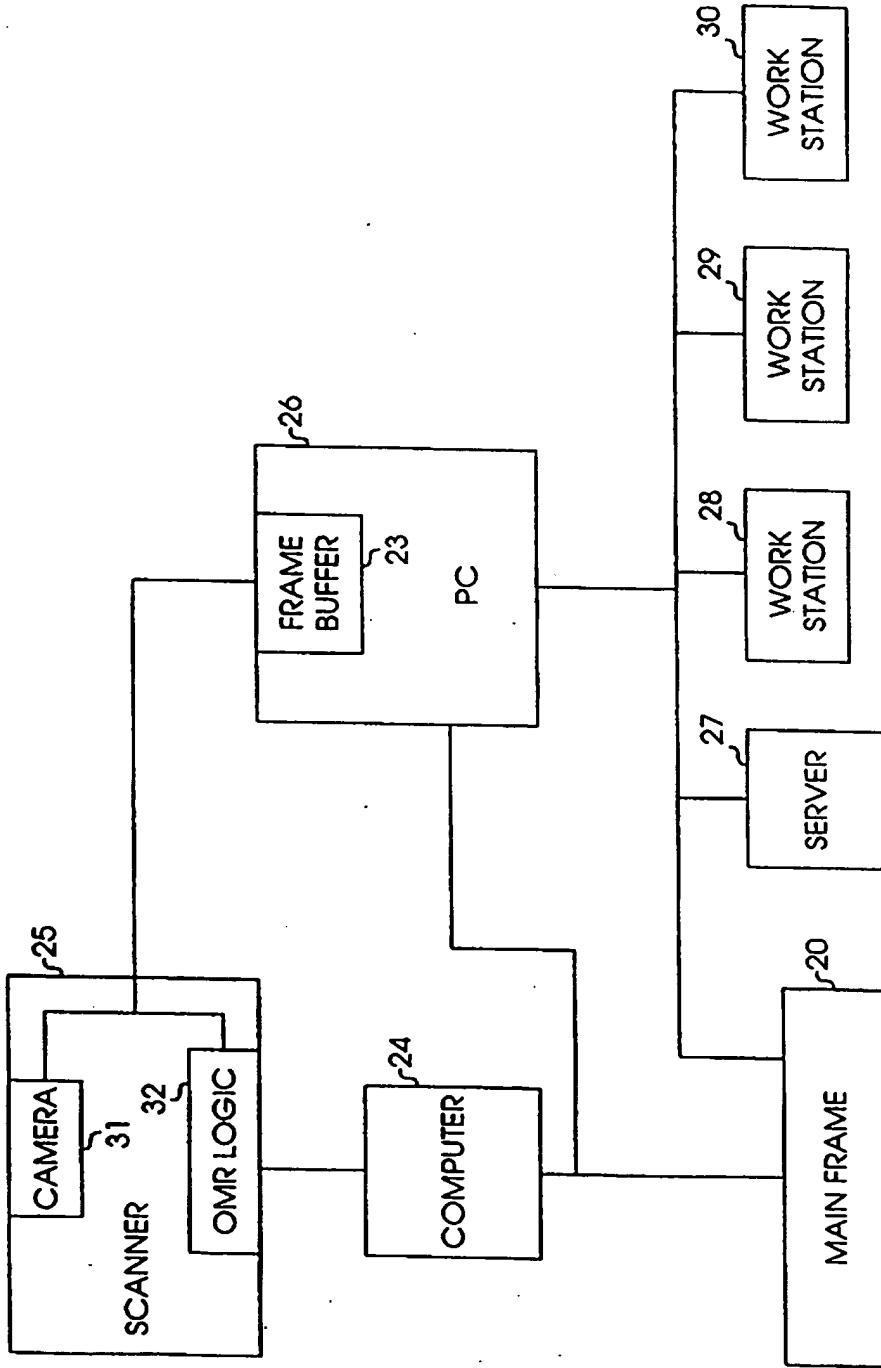

Fig. 2

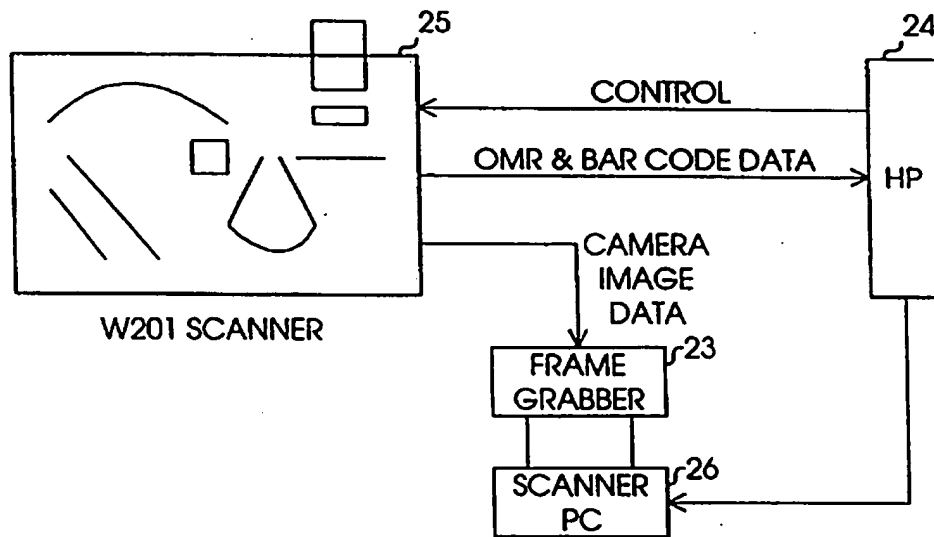

Fig. 3

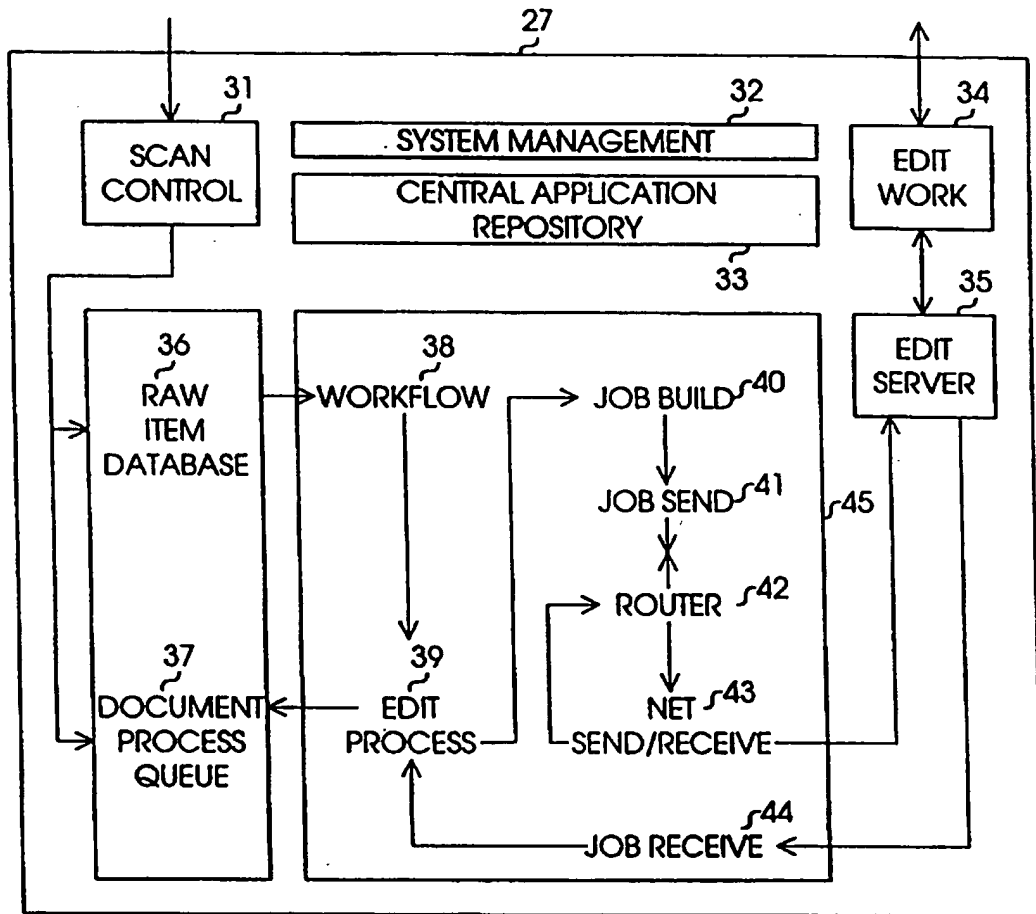

Fig. 4

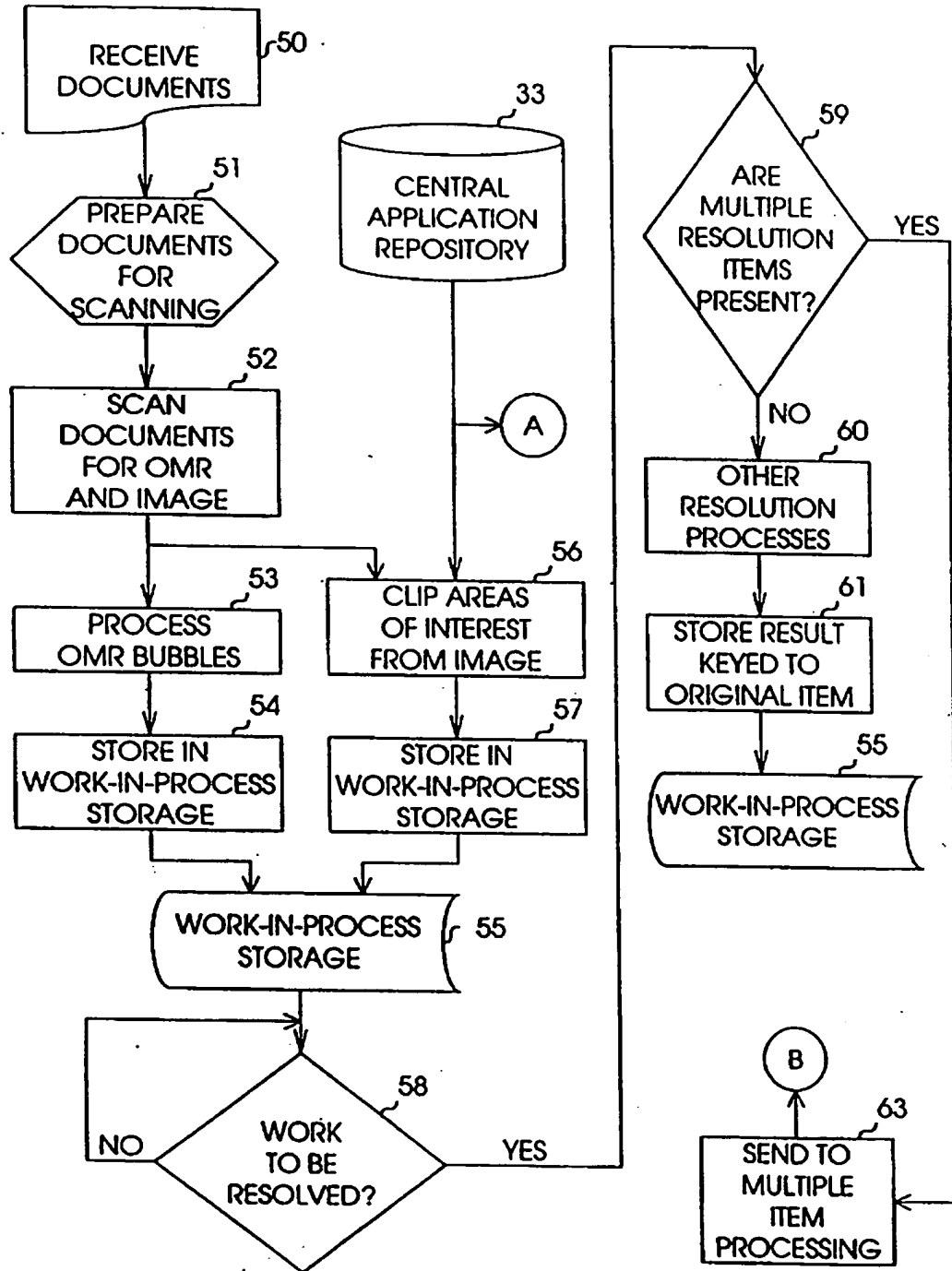
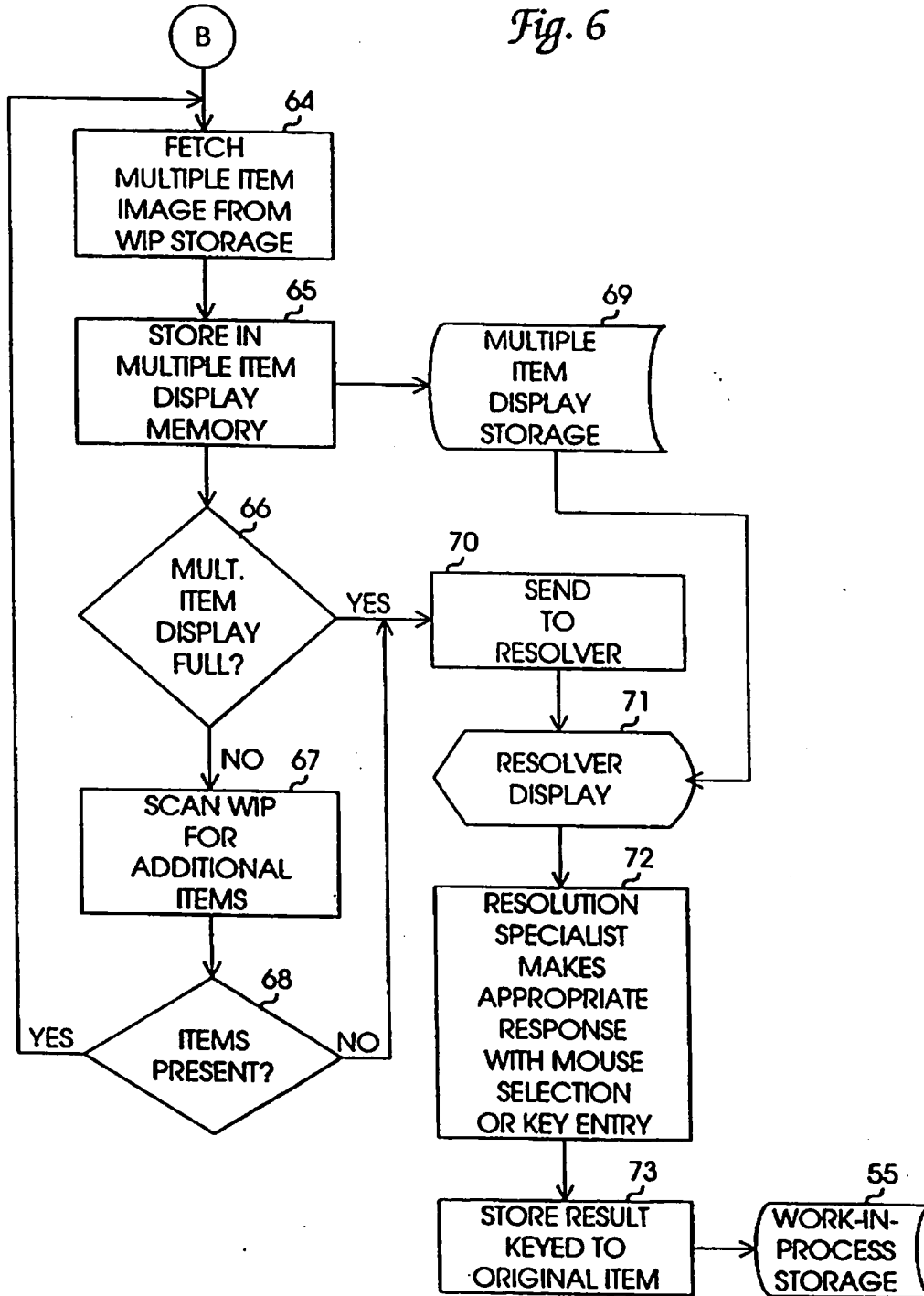

Fig. 5

Fig. 6



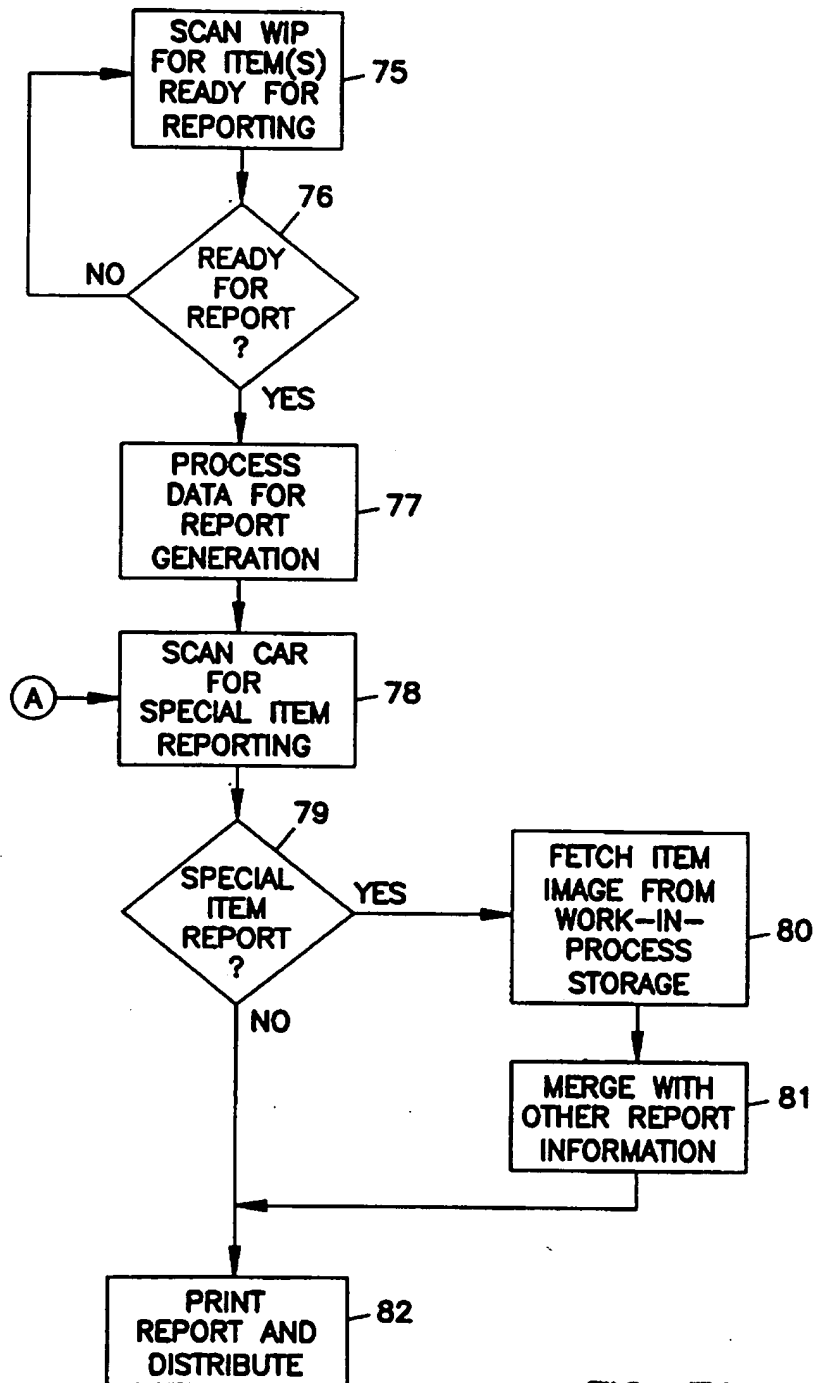

FIG. 7A

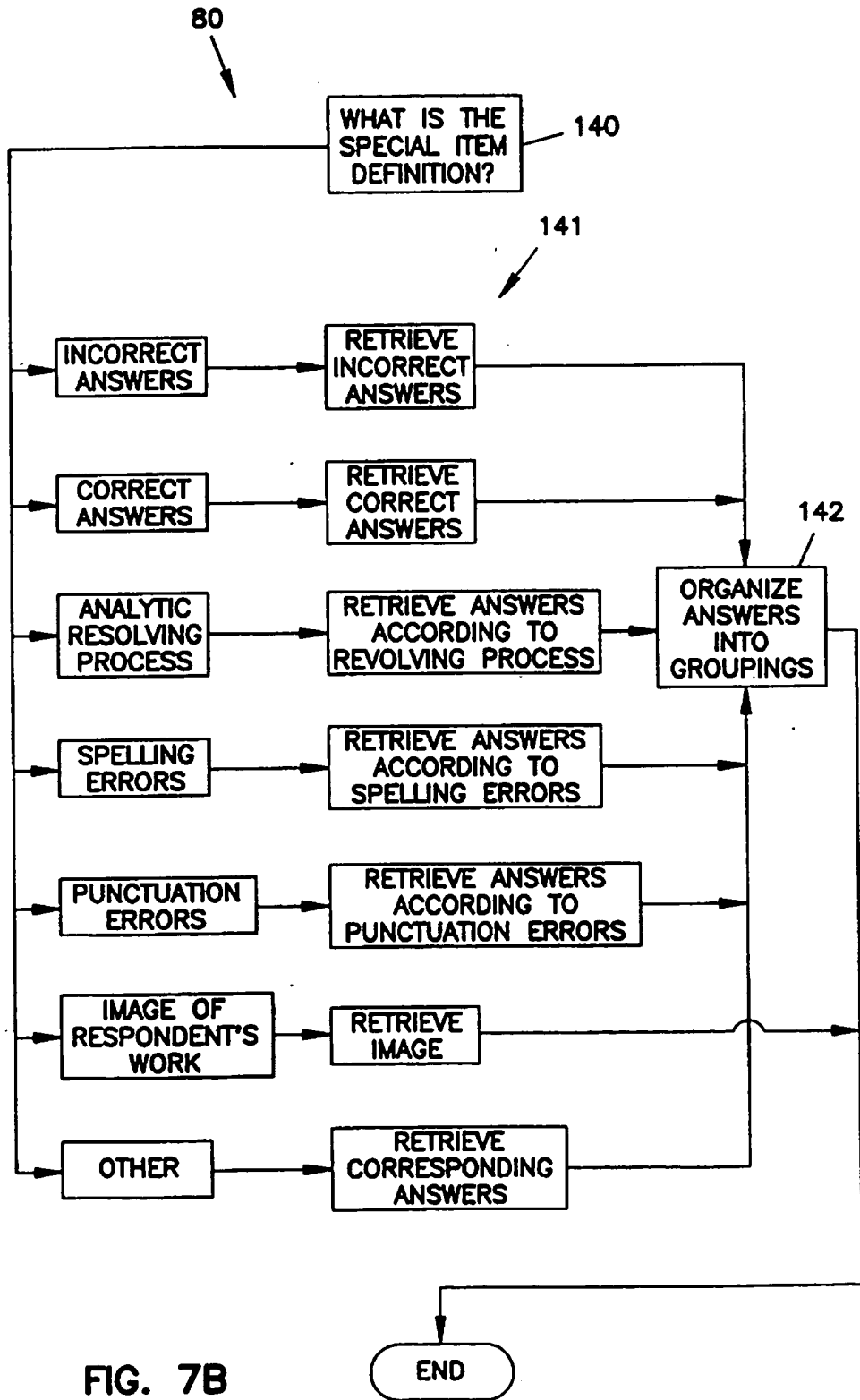

FIG. 7B

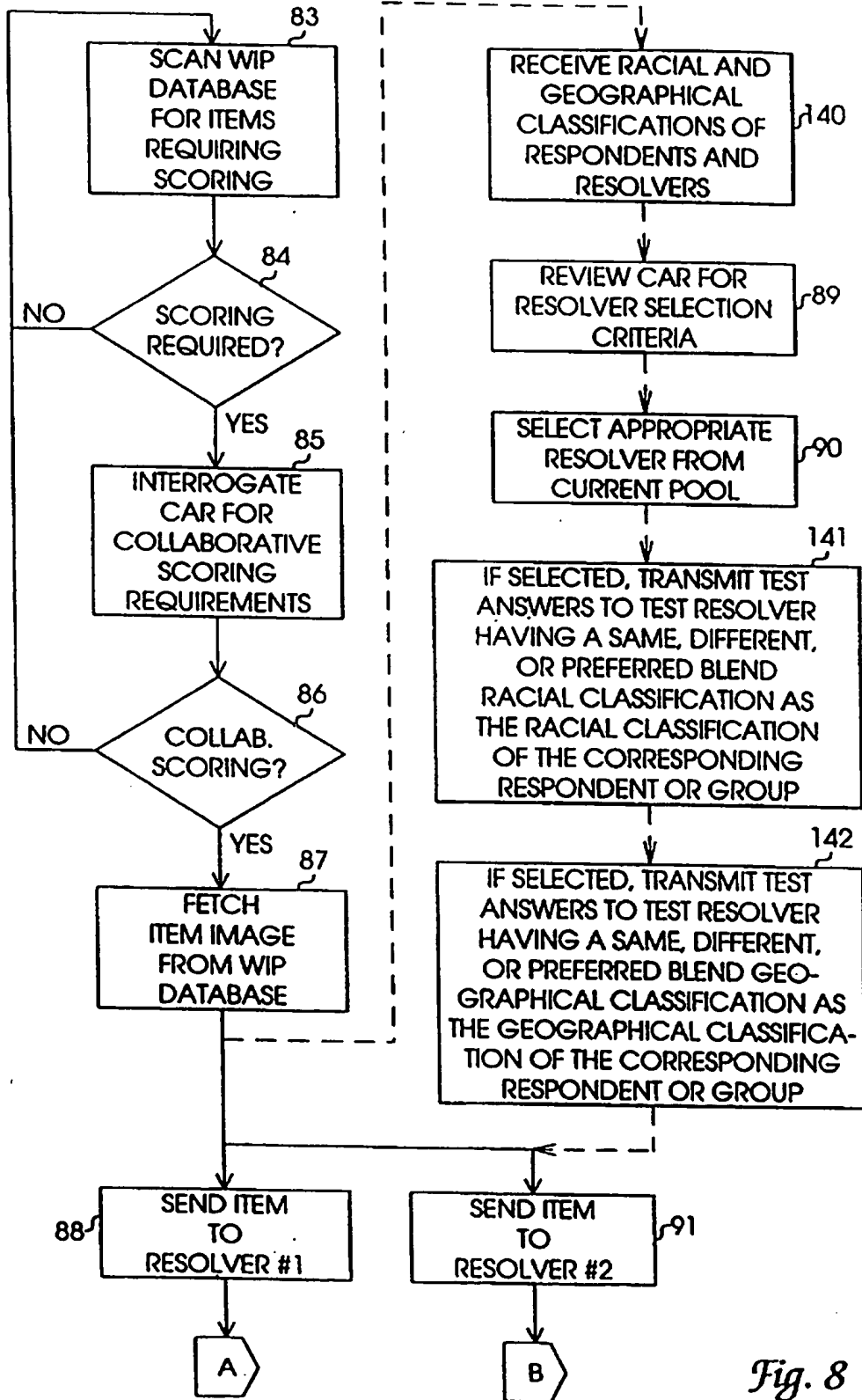
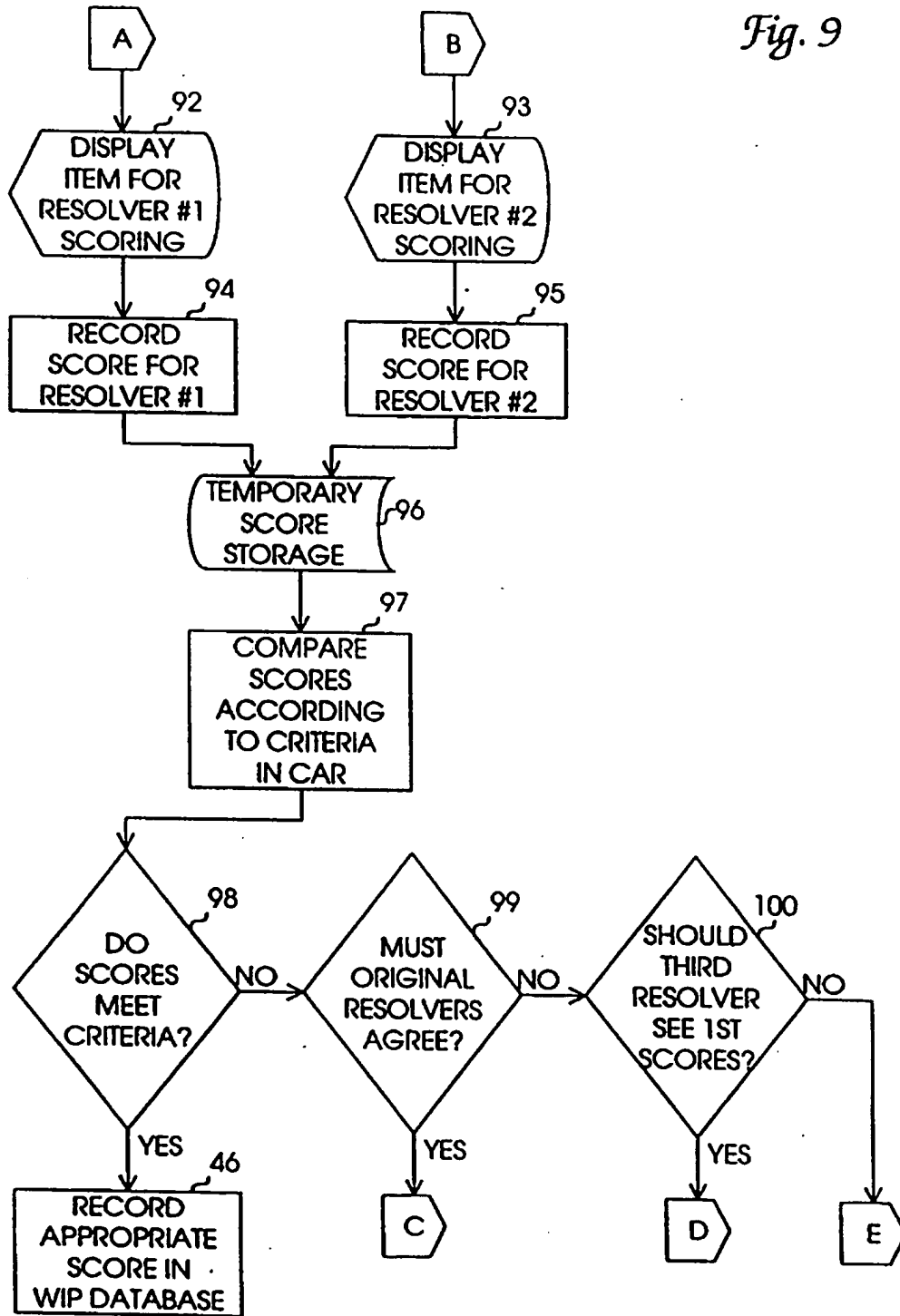

Fig. 8

Fig. 9



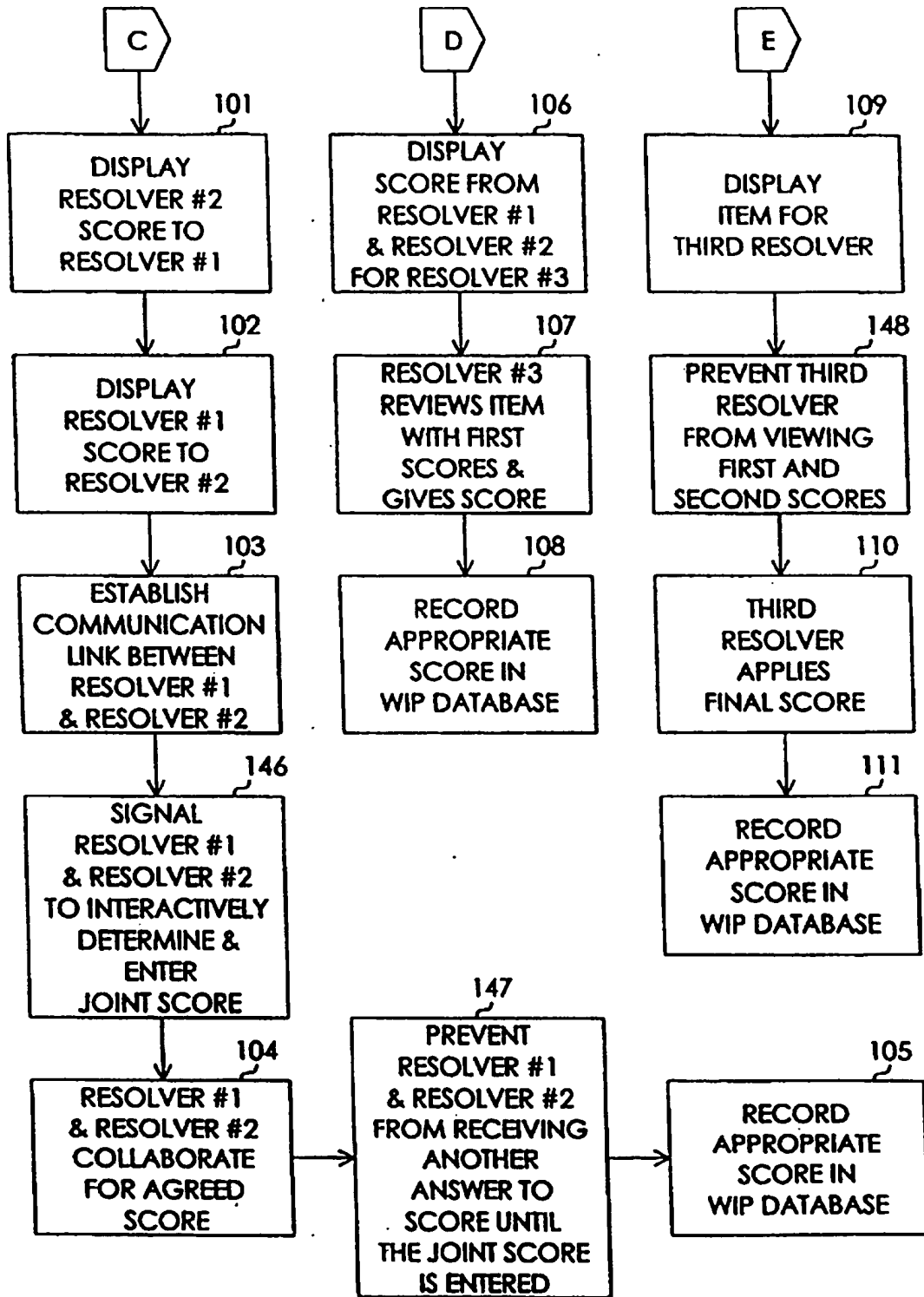

Fig. 10

Fig. 11

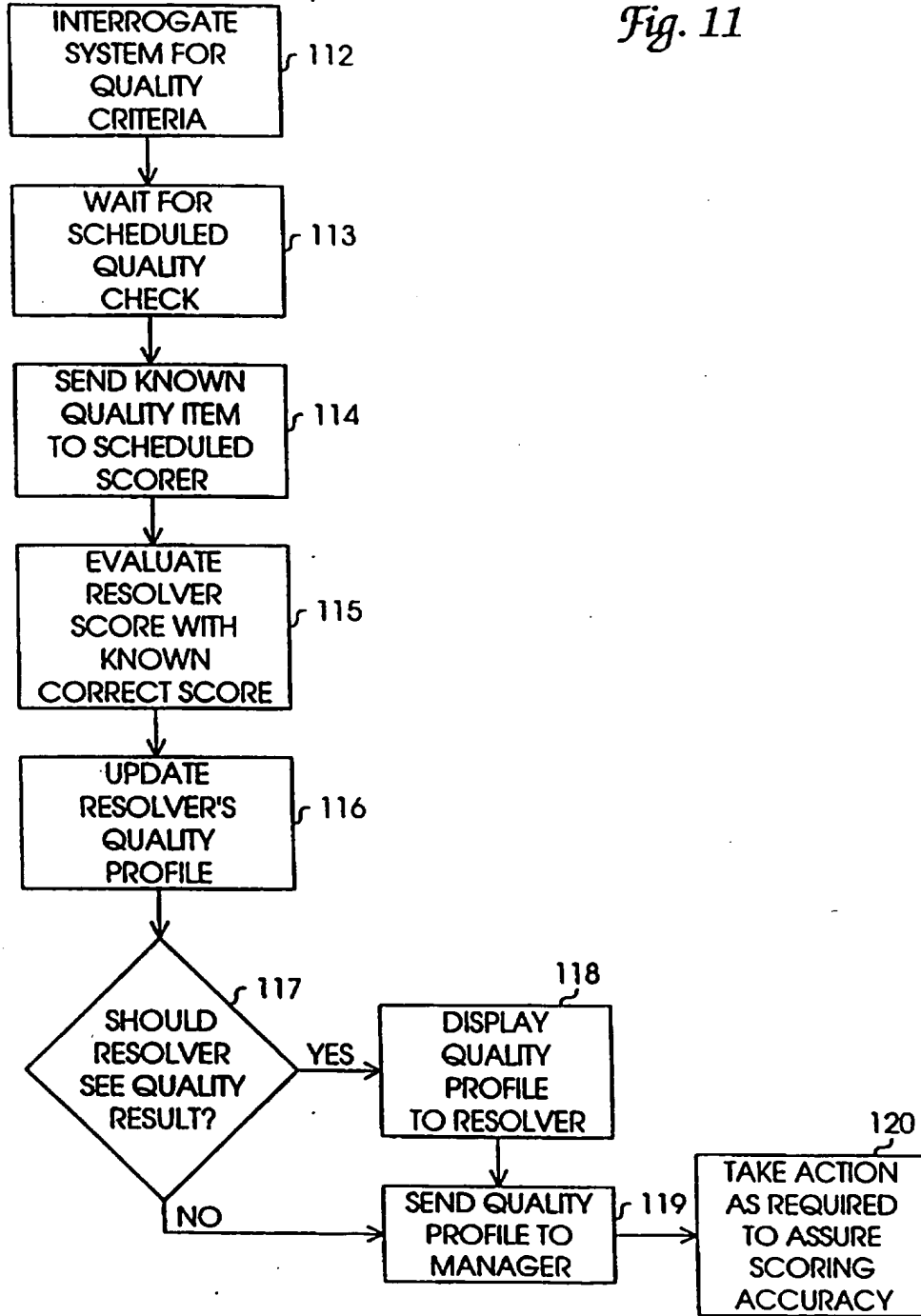
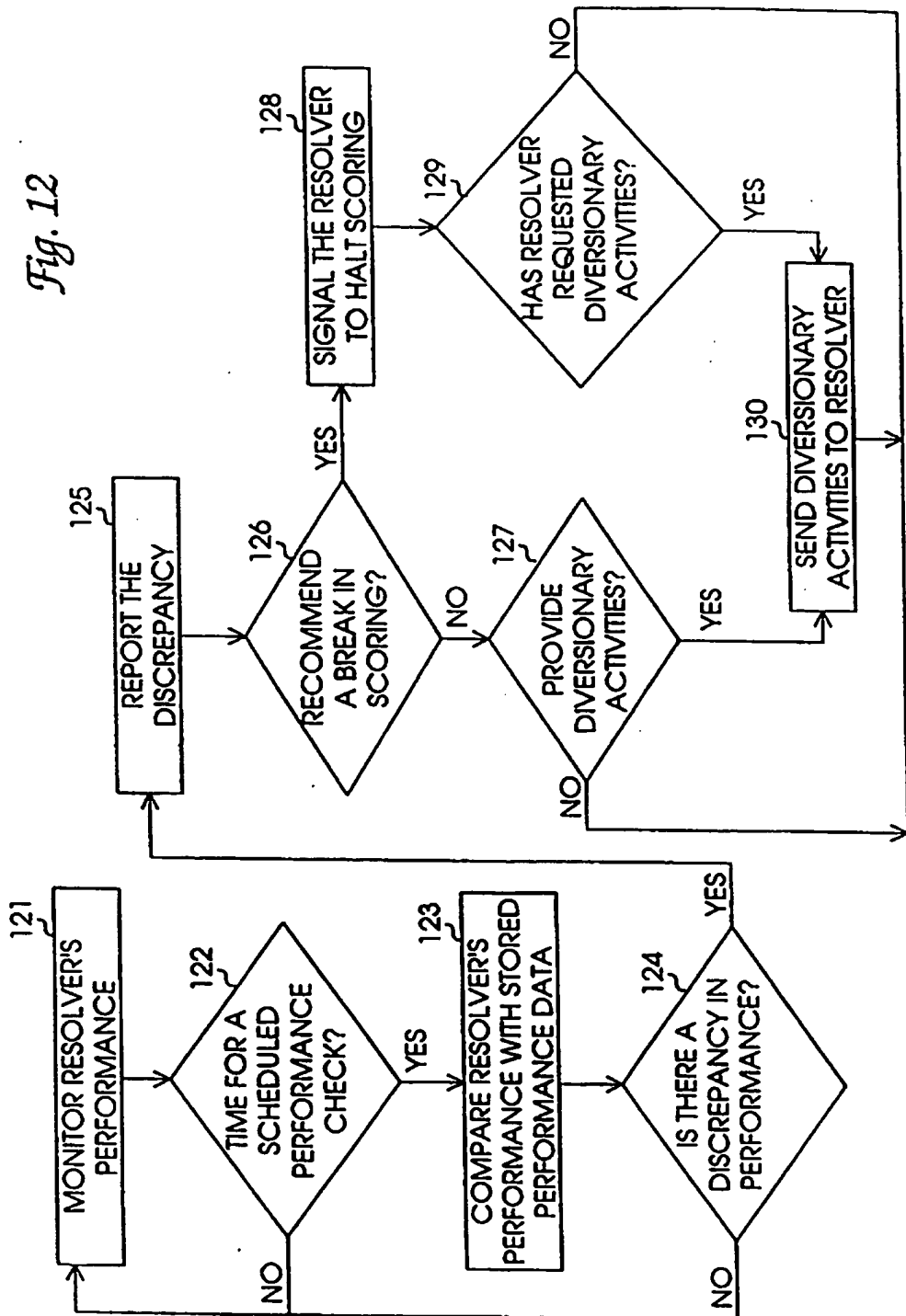

Fig. 12



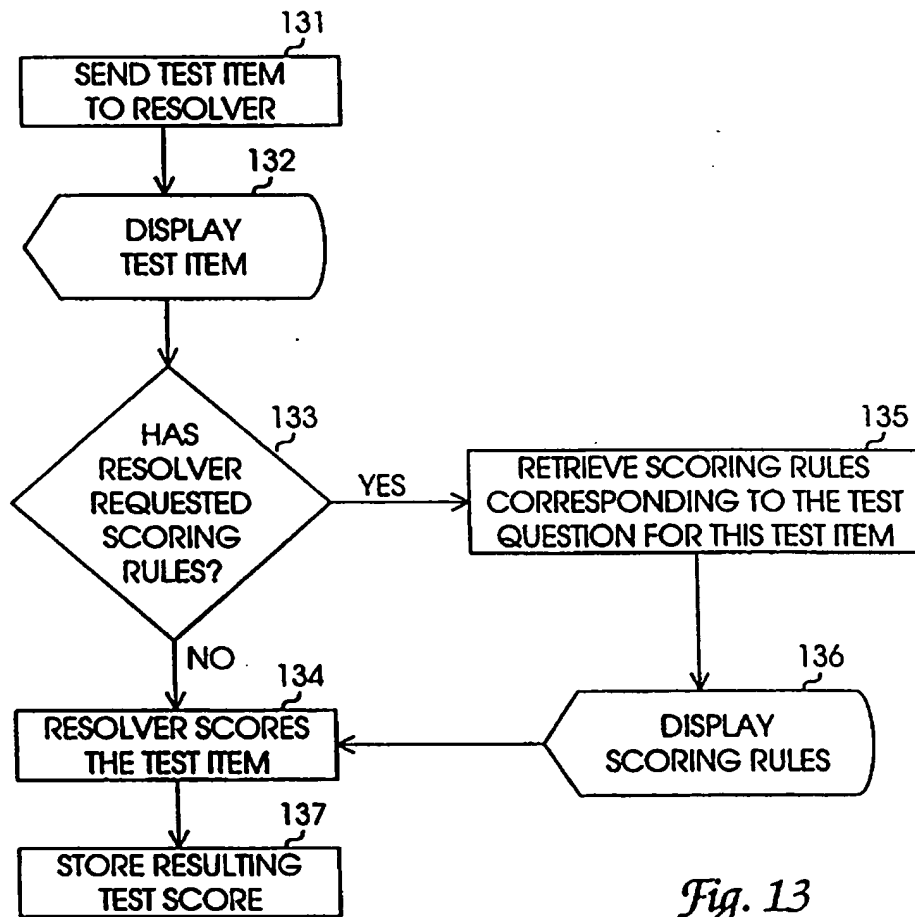

Fig. 13

74
↙

4	4	2	4	four
4	4	6	4	4
7	two	4	4	4
6	4	4	4	
4	4	six		6
4	4	2	4	4

Fig. 14